

Espacios públicos



Accesibilidad

161 Access

163 Meridian

163 The Gap Square

164 The Gap Round

165 Mamparas Access

166 Access Pro

171 Victoria Pro

Colectividades

172 Public Touchless

173 Public

175 Superinox

Placas de accionamiento

176 PL3 PRO antivandálica

176 PL10 PRO antivandálica

176 PL10-E

Urinaríos

177 Proton

177 Euret

177 Site

178 Spun

178 Chic

178 Mini

179 Pack Chic + Fluent

179 Pack Mini + Instant

179 Separadores

179 Recambios comerciales

Griferías electrónicas181 Ona-E ^N

181 Cala-E

182 L30-E

182 L20-E

182 Loft-E ^N

184 Sentronic-E

Dosificador electrónico

185 Ona

Fluxores electrónicos

185 Sentronic-R

185 Sentronic-S

185 Sentronic-V

Griferías temporizadas

186 Instant

187 Instant Care

188 Instant Foot

189 Instant Pro

190 Fluent

191 Avant ^N

194 Fluxores

Lavaderos

196 Henares

Lavabos colectivos

196 Access

Tazas infantiles

197 Happening Baby

197 Baby

Placas turcas

197 Oriental

Trituradores sanitarios

198 D-Trit

198 The Gap Round D-Trit

Tanques altos

198 Universal

Vertederos

198 Garda

Compatibilidad maneta gerontológica
con todas las griferías de las series:



A525003000 AG0255300R AG0255400R

Victoria	•		
Victoria Plus		•	•
L20	•		
Cala*		•	•
Atlas	•		
Targa*		•	•

* Compatibilidad funcional, precisa adaptador













PROTON

^N Novedad

Iconografía

Porcelana y productos accesibilidad

	x / x litros Mecanismo de descarga dual	Inodoros equipados con un dispositivo que ahorra agua, eligiendo entre dos tipos de descarga agua: 6/3, 4,5/3 o 4/2 litros de agua		Fácil extracción	Sistema que facilita la instalación y extracción de la tapa y asiento para optimizar la limpieza
	Asiento de caída amortiguada	Sistema que amortigua la caída del asiento y la tapa, evitando molestias y sobresaltos innecesarios		Movilidad reducida	Producto adaptado para usuarios con movilidad reducida
	Altura Comfort	Inodoros y bidés de con una altura de 44 cm para más comodidad		Sin contacto	Accionamiento sin contacto
	Roca Rimless®	Sistema que facilita la limpieza de la taza y maximiza su higiene, superando los estándares de higiene de la UE		Infantil	Productos diseñados con medidas adecuadas para uso infantil
	Compatible Multiclean®	Inodoros compatibles con Multiclean®		Grosor cristal	

Grifería

	Grifería electrónica	Grifería electrónica activable sin contacto		Limitador de caudal	Caudal de la grifería en litros
	Grifería temporizada	Accionamiento con temporizador automático			

Access

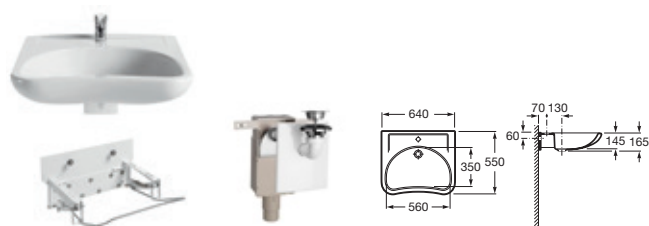

Lavabo mural movilidad reducida
con juego de fijación. Sin rebosadero, desagüe ni sifón

		Blanco
640 x 550	A327230000	€ 98,30
Conjunto desagüe con rebosadero exterior y sifón empotrable	A506403207	€ 97,30
Soporte basculante mural para lavabo	A816323000	€ 518,00
Conjunto desagüe con sifón flexible	A892814000	€ 100,00



Lavabo mural de Stonex®
Con juego de fijación

		Blanco
850 x 550	A2W8004000	€ 495,00
Conjunto desagüe con sifón empotrado y rebosadero	A506403207	€ 97,30

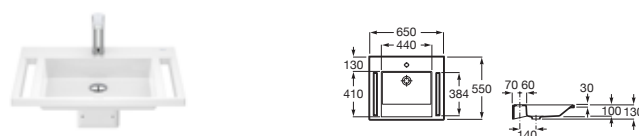

Lavabo mural de Stonex®
Con juego de fijación

		Blanco
650 x 550	A2W8003000	€ 380,00
Conjunto desagüe con sifón empotrado y rebosadero	A506403207	€ 97,30

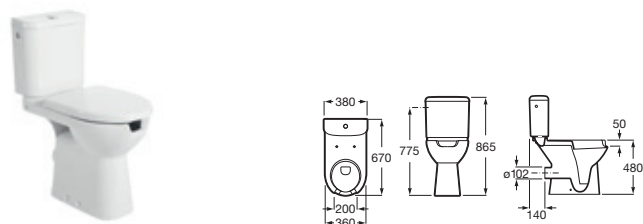

Inodoro de tanque bajo con apertura frontal
670 mm de longitud

		Blanco
Taza para tanque bajo de salida horizontal con juego de fijación. Altura 480 mm (sin asiento)	A342239000	€ 197,00
Tanque de alimentación lateral con tapa y mecanismo de doble pulsador 6/3 litros	A341230000	€ 164,00
Tanque de alimentación inferior con tapa y mecanismo de doble pulsador 6/3 litros	A341231000	€ 164,00
Asiento y tapa con aro abierto, para taza con apertura frontal	A80123C004	€ 68,50
Asiento y tapa de caída amortiguada	A801C4200U	€ 102,00
Asiento y tapa con fijaciones reforzadas	A801230001	€ 112,00

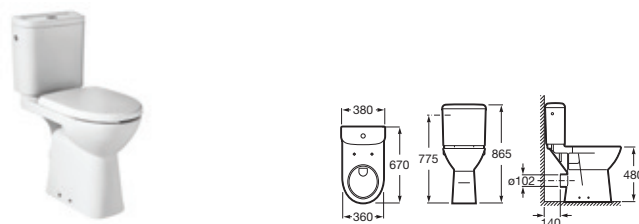
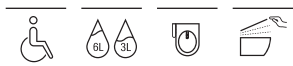

Inodoro de tanque bajo
670 mm de longitud

		Blanco
Taza para tanque bajo de salida horizontal con juego de fijación. Altura 480 mm (sin asiento)	A342236000	€ 151,00
Tanque de alimentación lateral con tapa y mecanismo de doble pulsador 6/3 litros	A341230000	€ 164,00
Tanque de alimentación inferior con tapa y mecanismo de doble pulsador 6/3 litros	A341231000	€ 164,00
Asiento y tapa de caída amortiguada	A801232004	€ 96,50
Asiento con aro abierto y tapa con bisagras de acero inoxidable	A801230004	€ 68,50
Asiento con aro cerrado y tapa con bisagras de acero inoxidable	A80123A004	€ 68,50
Aro abierto con bisagras de acero inoxidable	A80123D004	€ 54,70
Asiento y tapa con fijaciones reforzadas	A801230001	€ 112,00

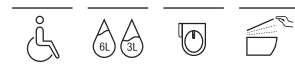

Access

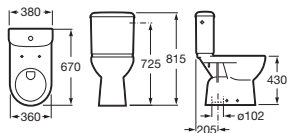

Inodoro de tanque bajo

670 mm de longitud

Blanco

Taza para tanque bajo de salida vertical con juego de fijación. Altura 430 mm (sin asiento)	A342237000	€ 151,00
Tanque de alimentación lateral con tapa y mecanismo de doble pulsador 6/3 litros	A341230000	€ 164,00
Tanque de alimentación inferior con tapa y mecanismo de doble pulsador 6/3 litros	A341231000	€ 164,00
Asiento y tapa de caída amortiguada	A801232004	€ 96,50
Asiento con aro abierto y tapa con bisagras de acero inoxidable	A801230004	€ 68,50
Asiento con aro cerrado y tapa con bisagras de acero inoxidable	A80123A004	€ 68,50
Aro abierto con bisagras de acero inoxidable	A80123D004	€ 54,70
Asiento y tapa con fijaciones reforzadas	A801230001	€ 112,00

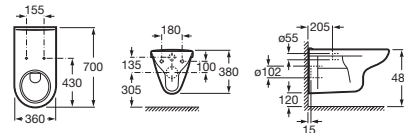
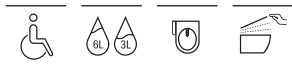

Inodoro suspendido

700 mm de longitud

Blanco

Taza suspendida	A346237000	€ 242,00
Taza suspendida Roca Rimless®	A346239000	€ 242,00
Asiento y tapa de caída amortiguada	A801232004	€ 96,50
Asiento con aro abierto y tapa con bisagras de acero inoxidable	A801230004	€ 68,50
Asiento con aro cerrado y tapa con bisagras de acero inoxidable	A80123A004	€ 68,50
Aro abierto con bisagras de acero inoxidable	A80123D004	€ 54,70
Asiento y tapa con fijaciones reforzadas	A801230001	€ 112,00

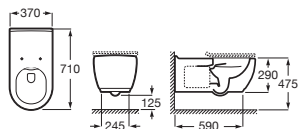

Inodoro suspendido

700 mm de longitud

Blanco

Taza suspendida Roca Rimless®	A346236000	€ 253,00
Asiento y tapa con fijaciones reforzadas	A801230001	€ 112,00
Asiento y tapa de caída amortiguada	A801C4200U	€ 102,00



Meridian

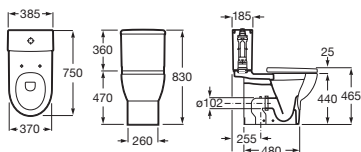

Inodoro de tanque bajo movilidad reducida

750 mm de longitud

Blanco

Taza de salida dual con juego de fijación	A34224H000	€ 263,00
Tanque completo con juego de mecanismos de doble descarga 6/3 l	A34124H000	€ 226,00
Asiento y tapa con bisagras de acero inoxidable	A801230004	€ 68,50
Aro con bisagras de acero inoxidable	A80123D004	€ 54,70
Asiento y tapa de caída amortiguada	A801C4200U	€ 102,00
Asiento y tapa con fijaciones reforzadas	A801230001	€ 112,00

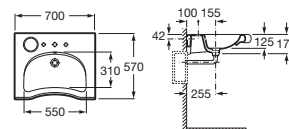
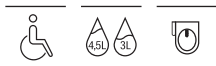

Lavabo mural movilidad reducida

con juego de fijación

Blanco

700 x 570	A32724H000	€ 193,00
-----------	-------------------	----------



The Gap Square

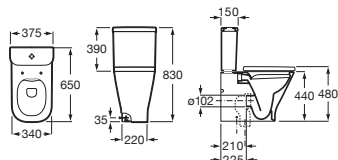

Inodoro de tanque bajo Comfort adosado a pared

650 mm de longitud

Blanco

Taza de tanque bajo Roca Rimless®, salida de evacuación dual. Incluye codo de evacuación. Altura 440 mm (sin asiento)	A3421AC000	€ 181,00
Tanque de alimentación inferior completo con: Juego de mecanismos de doble descarga 4,5/3 litros, regulable a 4/2L. Botonera elevada Ø50 mm	A34147H000	€ 167,00
Tanque de alimentación inferior completo con: Juego de mecanismos de doble descarga 4,5/3 litros, regulable a 4/2 litros.	A341470000	€ 167,00
Tanque de alimentación lateral completo con: Juego de mecanismos de doble descarga 4,5/3 litros, regulable a 4/2 litros	A341471000	€ 167,00
Asiento y tapa de Supralit®, de caída amortiguada	A80147200B	€ 113,00
Asiento y tapa de Supralit®	A80147000B	€ 60,70

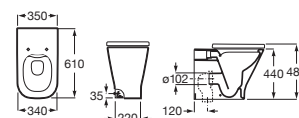
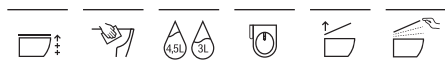

Inodoro de tanque alto Comfort adosado a pared

610 mm de longitud

Blanco

Taza de tanque alto Roca Rimless®, salida de evacuación dual. Altura 440 mm (sin asiento)	A347479000	€ 237,00
Asiento y tapa de Supralit®, de caída amortiguada	A80147200B	€ 113,00
Asiento y tapa de Supralit®	A80147000B	€ 60,70

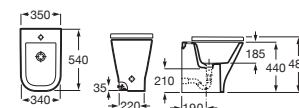
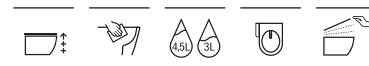

Bidé Comfort adosado a pared

540 mm de longitud

Blanco

Bidé. Altura 440 mm (sin tapa bidé)	A35747C000	€ 153,00
Tapa bidé de Supralit®, de caída amortiguada	A80673200B	€ 129,00
Tapa bidé de Supralit®	A80673000B	€ 69,20

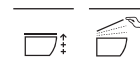

The Gap Round

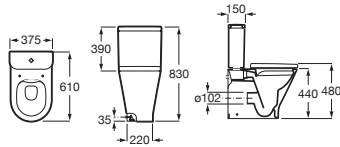

Inodoro compacto de tanque bajo Comfort adosado a pared

610 mm de longitud

Blanco

Taza compacta Roca Rimless® de tanque bajo Comfort adosada a pared. Altura 440 mm (sin asiento)	A3420NJ000	€ 184,00
Tanque completo con: Juego de mecanismos de doble descarga 4,5/3 litros alimentación inferior	A3410N0000	€ 167,00
Tanque completo con: Juego de mecanismos de doble descarga 4,5/3 litros alimentación lateral	A3410N1000	€ 167,00
Asiento y tapa de Supralit® de caída amortiguada	A801D22001	€ 129,00
Asiento y tapa de Supralit®	A801D20001	€ 69,00

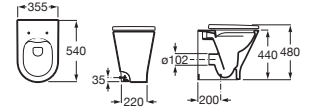

Inodoro de tanque alto Comfort adosado a pared

540 mm de longitud

Blanco

Taza Roca Rimless® de tanque alto Comfort adosada a pared. Altura 440 mm (sin asiento)	A3470N8000	€ 203,00
Asiento y tapa de Supralit® de caída amortiguada	A801D12001	€ 113,00
Asiento y tapa de Supralit®	A801D10001	€ 60,70

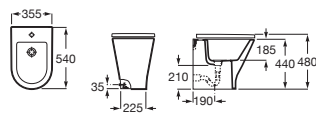

Bidé Comfort adosado a pared

540 mm de longitud

Blanco

Bidé. Altura 440 mm (sin tapa bidé)	A3570N9000	€ 153,00
Tapa bidé de Supralit® de caída amortiguada	A806D12001	€ 113,00
Tapa bidé de Supralit®	A806D10001	€ 60,70

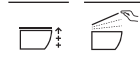

Mamparas Access

Altura 1950 mm

Frontal

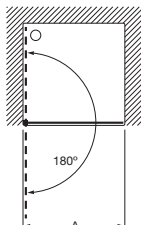

Access PE

Frontal ducha de 1 hoja batiente dividida en dos partes independientes

Cristal
Transparente

Medidas (A)	Plata brillo
670 - 800	€ 983,00
801 - 1000	€ 1.042,00

Compensación: 25 mm por cada lado.

El tratamiento MaxiClean (M) supone un coste adicional de: +40€ (en total)

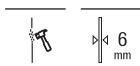

Angular

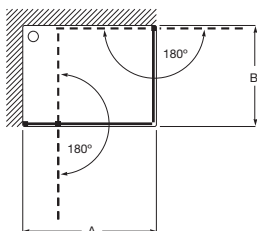

Access PLF + PL

Angular ducha de 1 hoja batiente dividida en dos partes independientes + 1 fija + 1 hoja batiente dividida en dos partes independientes

Cristal
Transparente

PLF (A)	Apertura puerta	Plata brillo
970 - 1100	615	€ 1.220,00
1101 - 1200	640	€ 1.230,00
1201 - 1400	645	€ 1.243,00

PL (B)		
600 - 800	-	€ 888,00
801 - 1000	-	€ 950,00

Compensación: 15 mm por cada lado.

Para precio total sumar ambos lados (A + B).

El tratamiento MaxiClean (M) supone un coste adicional de: +111€ (en total)

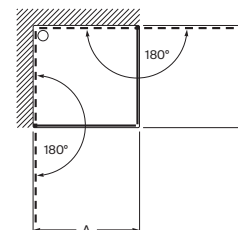
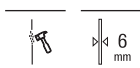

Access 2PL

Angular ducha de 2 hojas batientes divididas en dos partes independientes

Cristal
Transparente

Medidas (A o B)	Plata brillo
600 - 800	€ 888,00
801 - 1000	€ 950,00

Compensación: 25 mm por cada lado.

Para precio total sumar ambos lados (A + B).

El tratamiento MaxiClean (M) supone un coste adicional de: +84€ (en total)

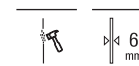

No se admiten devoluciones en ningún producto configurable

Medidas en mm
Toda factura tendrá el recargo del IVA / La presente tarifa anula las anteriores
El montaje no está incluido en el precio

MaxiClean OPCIONAL
Acabados cristales: Transparente
Perfiles: Plata brillo



Tomando como referencia el vértice de la mampara, determinamos la posición derecha o izquierda

Access Pro

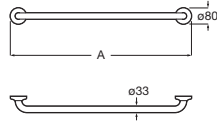

Asas rectas de baño		A		
Vinilo blanco brillante. Antibacteriano	900	A816980009	€ 138,00	
	700	A816979009	€ 122,00	
	600	A816978009	€ 98,00	
	400	A816977009	€ 83,50	
	300	A816976009	€ 77,20	

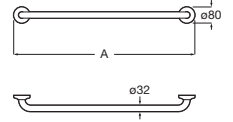

Asas rectas de baño		A		
Acero inoxidable brillante	900	A816930001	€ 71,50	
	700	A816929001	€ 62,70	
	600	A816928001	€ 58,70	
	400	A816927001	€ 50,20	
	300	A816926001	€ 48,50	

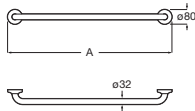

Asas rectas de baño		A		
Acero inoxidable mate	900	A816930002	€ 69,80	
	700	A816929002	€ 61,20	
	600	A816928002	€ 57,30	
	400	A816927002	€ 48,80	
	300	A816926002	€ 47,50	

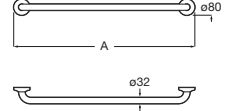

Asas rectas de baño		A		
Acero blanco brillante	900	A816904009	€ 38,70	
	700	A816903009	€ 34,50	
	600	A816902009	€ 31,50	
	400	A816901009	€ 29,20	
	300	A816900009	€ 26,80	

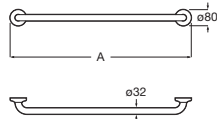

Asas rectas de baño		A		
Acero negro mate	900	A816904NBO	€ 67,80	
	700	A816903NBO	€ 59,50	
	600	A816902NBO	€ 55,70	
	400	A816901NBO	€ 47,70	
	300	A816900NBO	€ 46,20	

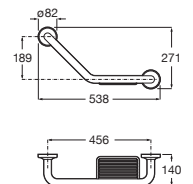
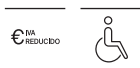

Asa angular de baño 135° con jabonera			
Acero inoxidable brillante	A816936001	€ 120,00	



Access Pro

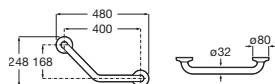

Asa angular de baño 135°

Vinilo blanco brillante. Antibacteriano	A816982009	€ 99,30
---	-------------------	---------

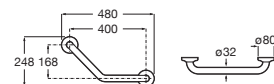

Asa angular de baño 135°

Acero inoxidable brillante	A816931001	€ 66,30
Acero inoxidable mate	A816931002	€ 65,00
Acero blanco brillante	A816905009	€ 48,50
Acero negro mate	A816905NB0	€ 73,00

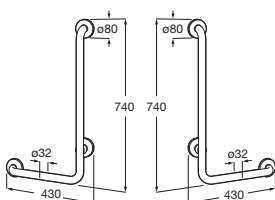
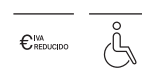

Asa angular de baño 90°

Vinilo blanco brillante. Antibacteriano	Izquierda	A816983009	€ 197,00
	Derecha	A816984009	€ 197,00

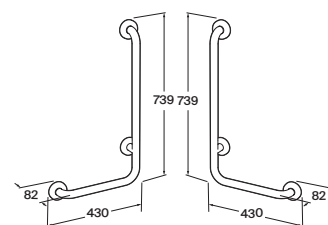

Asa angular de baño 90°

Acero inoxidable brillante	Izquierda	A816906C00	€ 123,00
	Derecha	A816907C00	€ 123,00
Acero inoxidable mate	Izquierda	A816906C20	€ 118,00
	Derecha	A816907C20	€ 118,00
Acero blanco brillante	Izquierda	A816906009	€ 84,00
	Derecha	A816907009	€ 84,00
Acero negro mate	Izquierda	A816906NB0	€ 117,00
	Derecha	A816907NB0	€ 117,00

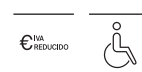

Colección Access Design en página 349, dentro del capítulo de Accesorios

Access Pro

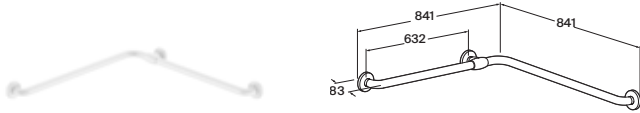

Asa angular de baño a dos paredes

800	Vinilo blanco brillante. Antibacteriano	A816938P30	€ 277,00
-----	---	-------------------	----------



Asa angular de baño a dos paredes

800	Acero inoxidable brillante	A816937C00	€ 144,00
	Acero inoxidable mate	A816937C20	€ 139,00
	Acero blanco brillante	A816937P30	€ 97,30
	Acero negro mate	A816937NBO	€ 136,00



Soporte deslizante para ducha de mano

Para asa recta o angular 90°. Ø33 mm

Vinilo blanco brillante	A816939P30	€ 41,00
-------------------------	-------------------	---------



Soporte deslizante para ducha de mano

Para asa recta o angular 90°. Ø32 mm

Acabado pulido	A816925C00	€ 44,20
Acabado mate	A816925C20	€ 43,20
Blanco brillante	A816925P30	€ 41,00
Negro mate	A816925NBO	€ 41,80

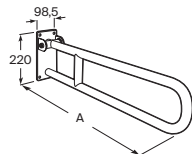

Asa abatible

A			
800	Acero inoxidable brillante	A816933001	€ 183,00
	Acero inoxidable mate	A816933002	€ 180,00
	Acero blanco brillante	A816909009	€ 102,00
	Acero negro mate	A816909NBO	€ 175,00
600	Acero inoxidable brillante	A816932001	€ 177,00
	Acero inoxidable mate	A816932002	€ 173,00
	Acero blanco brillante	A816908009	€ 95,50
	Acero negro mate	A816908NBO	€ 167,00

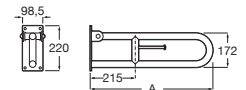
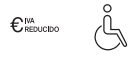

Asa abatible con portarrollo

A			
800	Acero inoxidable brillante	A816934001	€ 222,00
	Acero inoxidable mate	A816934002	€ 218,00
	Acero blanco brillante	A816916009	€ 121,00
	Acero negro mate	A816916NBO	€ 210,00
	600	Acero inoxidable brillante	A816935001
	Acero inoxidable mate	A816935002	€ 213,00
	Acero blanco brillante	A816935009	€ 118,00
	Acero negro mate	A816935NBO	€ 205,00



Access Pro

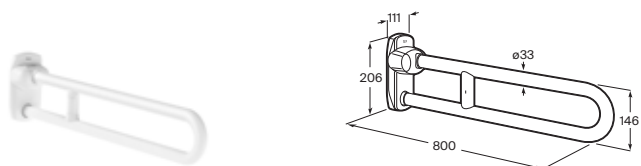

Asa abatible

800	Vinilo blanco brillante. Antibacteriano	A816986009	€ 392,00
-----	---	-------------------	----------



Portarrollo adaptable

Blanco brillante. Antibacteriano	A816911009	€ 38,30
----------------------------------	-------------------	---------

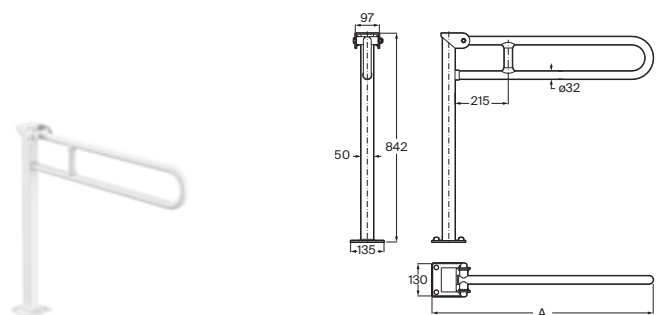

Asa abatible con pie

Acero			
A			
893	Acero blanco brillante	A816917P30	€ 215,00
	Acero negro mate	A816917NBO	€ 237,00
693	Acero blanco brillante	A816910009	€ 164,00
	Acero negro mate	A816910NBO	€ 230,00

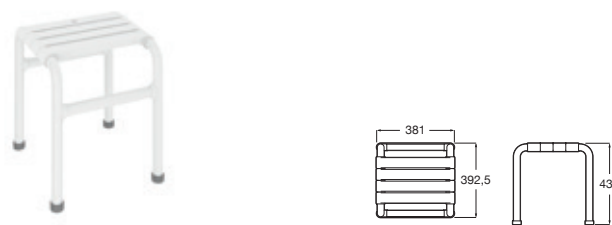

Taburete

Vinilo blanco brillante. Antibacteriano	A816988009	€ 387,00
---	-------------------	----------

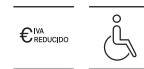

Asiento de ducha abatible

Blanco. Sin pies	A816912009	€ 185,00
------------------	-------------------	----------

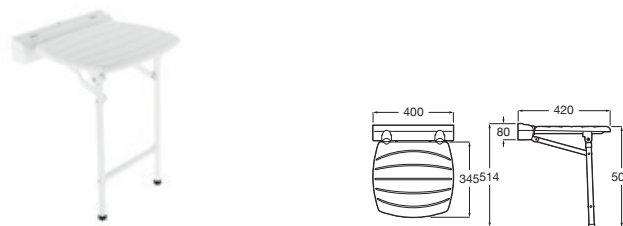
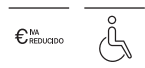

Asiento de ducha abatible

Blanco. Con pies	A816913009	€ 372,00
------------------	-------------------	----------



Access Pro



Asiento de ducha abatible

Blanco brillante. Antibacteriano **A816923P30** € 350,00

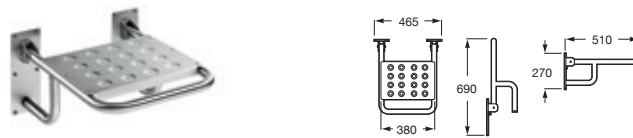

Asiento abatible

Acero inoxidable 380 x 510 **A816322000** € 347,00

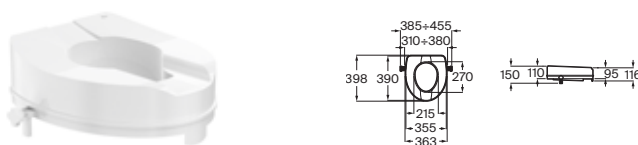

Asiento elevado WC

Blanco brillante **A816924P30** € 79,20

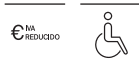

Espejo basculante

Acero inoxidable 600 x 800 **A812288000** € 315,00

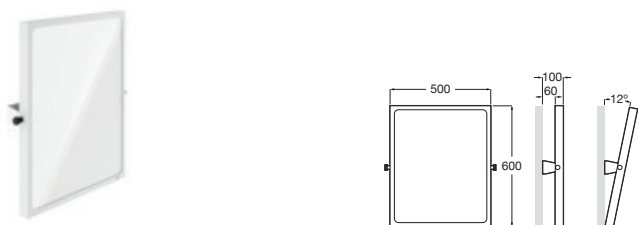

Espejo reclinable

Blanco brillante 600 x 500 **A816915009** € 285,00

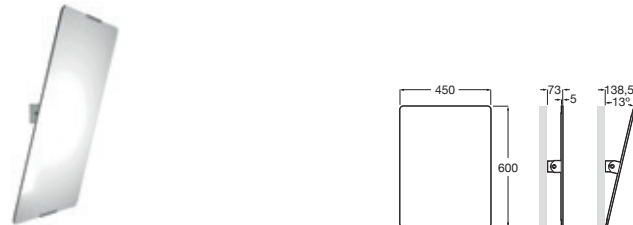

Espejo reclinable

600 x 450 **A816965009** € 267,00

Victoria Pro



Grifería para lavabo con cuerpo liso

Con enlaces de alimentación flexibles y maneta ergonómica alargada

Cromado	A5A325GC00	€ 109,00
---------	-------------------	----------



Grifería para lavabo con cuerpo liso

Con enlaces de alimentación flexibles y maneta alargada con hendidura

Cromado	A5A3D5GC00	€ 109,00
---------	-------------------	----------

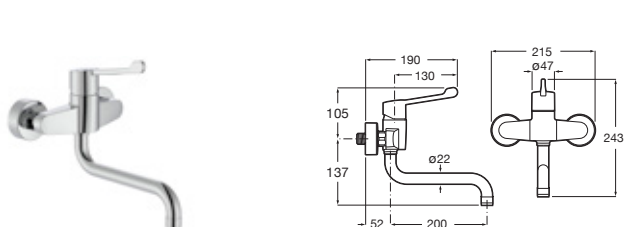

Grifería para lavabo / cocina / lavadero

Con caño inferior giratorio y maneta ergonómica alargada

Cromado	A5A765GC00	€ 203,00
---------	-------------------	----------

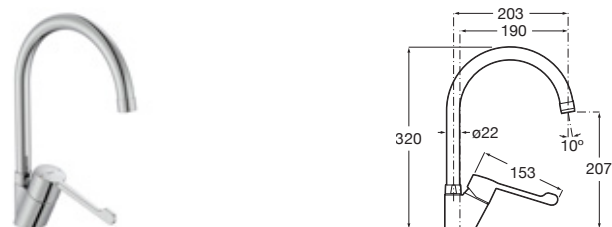

Grifería exterior para cocina

Con caño alto giratorio, enlaces de alimentación flexibles y maneta ergonómica alargada

Cromado	A5A8E5GC00	€ 119,00
---------	-------------------	----------

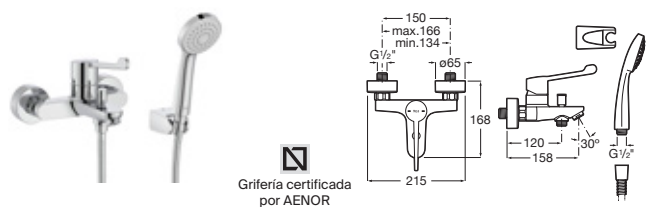

Grifería exterior para baño y ducha

Con inversor automático con retención, ducha de mano flexible de 1,70 m, soporte articulado y maneta ergonómica alargada

Cromado	A5A015GC00	€ 120,00
---------	-------------------	----------

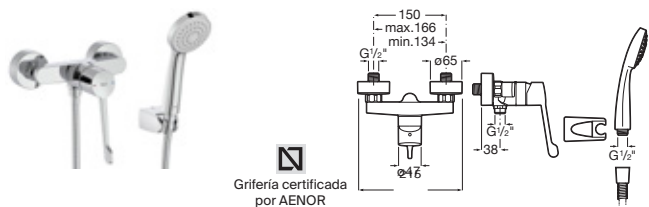

Grifería exterior para ducha

Con ducha de mano, flexible de 1,70 m, soporte articulado y maneta ergonómica alargada

Cromado	A5A205GC00	€ 106,00
---------	-------------------	----------



Public Touchless

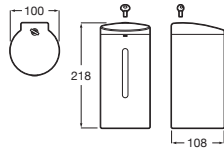

Dispensador de jabón o gel hidroalcohólico con sensor
700 ml

Acero inoxidable brillante	A818011000	€ 84,20
Acero inoxidable mate	A818011C20	€ 79,00
Acero blanco mate	A818011B00	€ 73,80
Acero negro mate	A818011NB0	€ 90,20

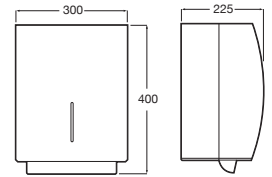
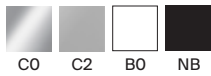

Dispensador de toallas automático con sensor
Ø21 cm

Acero inoxidable brillante	A818017001	€ 485,00
----------------------------	-------------------	----------

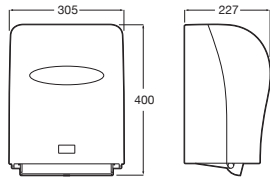

Dispensador de toallas automático con sensor
Ø21 cm

ABS Blanco	A818018009	€ 328,00
------------	-------------------	----------

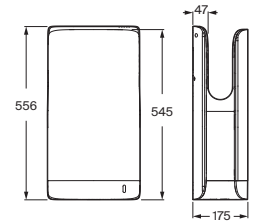

Secador de manos de alta velocidad con sensor
2.000 W

Blanco brillante	A817421P30	€ 700,00
------------------	-------------------	----------

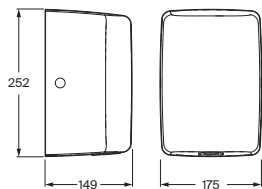

Secador de manos con sensor
1.250 W

Acero inoxidable brillante	A817420C00	€ 383,00
Acero inoxidable mate	A817420C20	€ 370,00
Acero blanco mate	A817420B00	€ 345,00
Acero negro mate	A817420NB0	€ 420,00

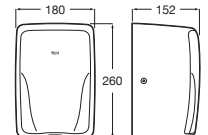
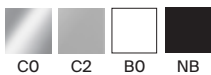

Secador de manos con sensor *
1.250 W

Acero inoxidable brillante	A818021001	€ 395,00
----------------------------	-------------------	----------



01



Public

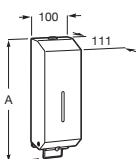

Dispensador de jabón líquido con palanca
1,2 litros

Acero inoxidable brillante	A817402001	€ 98,80
Acero inoxidable mate	A817402002	€ 97,20
Acero blanco mate	A817402B00	€ 87,50
Acero negro mate	A817402NBO	€ 107,00

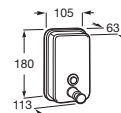

Dispensador de jabón líquido con pulsador
800 ml

Acero inoxidable brillante	A817404001	€ 41,80
Acero inoxidable mate	A817404002	€ 41,30
Acero blanco mate	A817404B00	€ 37,30
Acero negro mate	A817404NBO	€ 45,50

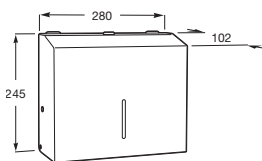

Dispensador toallas
200 unid.

Acero inoxidable brillante	A817410001	€ 202,00
Acero inoxidable mate	A817410002	€ 197,00
Acero blanco mate	A817410B00	€ 178,00
Acero negro mate	A817410NBO	€ 217,00

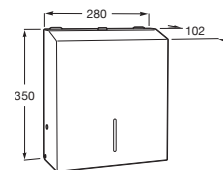

Dispensador toallas
400 - 600 unid.

Acero inoxidable brillante	A817411001	€ 222,00
Acero inoxidable mate	A817411002	€ 218,00
Acero blanco mate	A817411B00	€ 197,00
Acero negro mate	A817411NBO	€ 242,00

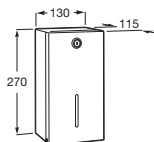

Dispensador papel higiénico
2 rollos

Acero inoxidable brillante	A817408001	€ 69,80
Acero inoxidable mate	A817408002	€ 68,50
Acero blanco mate	A817408B00	€ 61,50
Acero negro mate	A817408NBO	€ 75,30

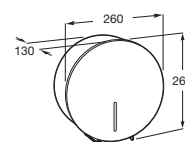

Dispensador papel higiénico
Ø260 mm

Acero inoxidable brillante	A817406001	€ 52,30
Acero inoxidable mate	A817406002	€ 51,70
Acero blanco mate	A817406B00	€ 46,30
Acero negro mate	A817406NBO	€ 56,70



Colectividades

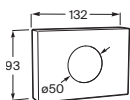

Dispensador bolsitas higiénicas

20 unid.

Acero inoxidable brillante	A817423C00	€ 29,70
Acero inoxidable mate	A817423C20	€ 26,80
Acero blanco mate	A817423B00	€ 26,00
Acero negro mate	A817423NBO	€ 32,70

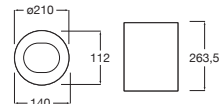

Papelera sin tapa

Acero inoxidable mate	6 litros	A817415002	€ 67,70
-----------------------	----------	-------------------	---------

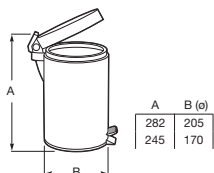

Papelera con tapa

Acero inoxidable mate	3 litros	A817413002	€ 42,80
	5 litros	A817414002	€ 63,50

Superinox



Colgador

Acero inoxidable mate **A817300002** € 29,80

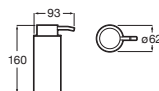

Dispensador jabón encimera

Acero inoxidable mate **A817312002** € 58,30

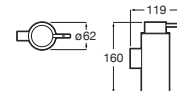

Dispensador jabón pared

Acero inoxidable mate **A817301002** € 65,00

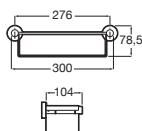

Jabonera ducha

Acero inoxidable mate **A817311002** € 86,70

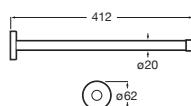

Toallero

Acero inoxidable mate **A817310002** € 50,00

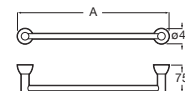

Toallero

		A		
Acero inoxidable	600	A817308002	€ 77,00	
mate	400	A817307002	€ 74,30	

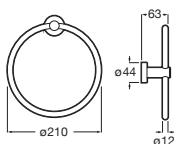

Toallero anilla

Acero inoxidable mate **A817309002** € 58,30

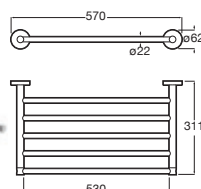

Toallero estante

Acero inoxidable mate **A817302002** € 162,00

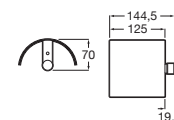

Portarrollo con tapa

Acero inoxidable mate **A817304002** € 52,80

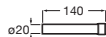

Portarrollo reserva

Acero inoxidable mate **A817303002** € 47,00

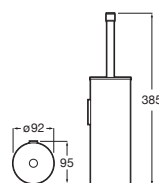

Escobillero pared

Acero inoxidable mate **A817305002** € 70,20

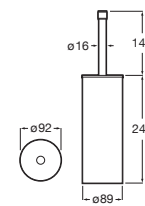

Escobillero suelo

Acero inoxidable mate **A817306002** € 58,30

Placas de accionamiento



PL3 PRO antivandálica

Placas de accionamiento
Acero inoxidable

Placa PL3 PRO Single	A890197104	€ 216,00
Placa PL3 PRO Dual	A890197004	€ 239,00



PL3-E PRO antivandálica

Placas de accionamiento
Acero inoxidable

Placa PL3-E PRO Dual electrónica. Autoflush	A890097500	€ 683,00
---	-------------------	----------

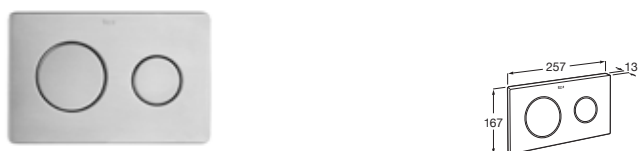

PL10 PRO antivandálica

Placas de accionamiento
Acero inoxidable

Placa PL10 PRO	A890189304	€ 238,00
----------------	-------------------	----------



PL10-E PRO antivandálica

Placas de accionamiento electrónicas
Acero inoxidable

Placa PL10-E PRO Dual electrónica. Autoflush	A890189500	€ 706,00
--	-------------------	----------



PL10-E

Placa de accionamiento electrónica
Cromada

Placa PL10-E. Dual electrónica. Autoflush	A890189510	€ 353,00
---	-------------------	----------



Urinarios

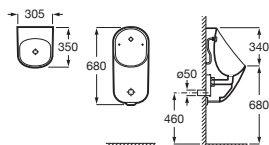

Proton

Urinario electrónico Roca Rimless®

Incluye kit de fijación, flexible de alimentación, sifón, tapón desagüe anti-vandálico y emisor-receptor electrónico

Blanco

Alimentación posterior con 4 pilas alcalinas 1,5 V LR6 (AA) **A3590J4000** € 415,00

Alimentación posterior con conexión a la red 230 V **A3590J5000** € 523,00

Ver cuadro compatibilidades grifería pág. 180

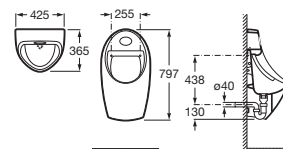

Euret

Urinario electrónico

Incluye llave de paso, sifón, kit de fijación, enchufe desagüe, flexible de alimentación y emisor-receptor electrónico

Blanco

Alimentación posterior con 4 pilas alcalinas 1,5 V LR6 (AA) **A35945E000** € 436,00

Alimentación posterior con conexión a la red 230 V **A35945M000** € 551,00

Ver cuadro compatibilidades grifería pág. 180

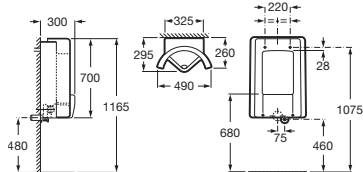

Site

Urinario

Incluye sifón flexible, codo, conector y tapón desagüe

Blanco

Alimentación posterior **A359605000** € 335,00

Ver cuadro compatibilidades grifería pág. 180

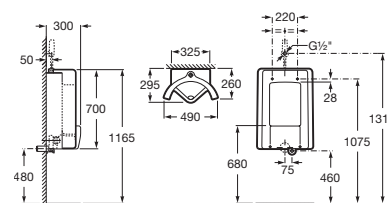

Site

Urinario

Incluye sifón flexible, codo, conector y tapón desagüe

Blanco

Alimentación superior. Adaptable a la pre-instalación de urinario Mural **A359607001** € 406,00

Alimentación superior **A359607000** € 335,00

Ver cuadro compatibilidades grifería pág. 180

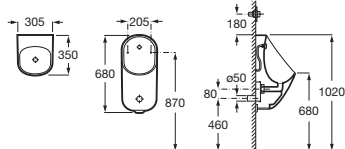

Proton

Urinario Roca Rimless®

Incluye kit de fijación, flexible de alimentación, sifón y tapón desagüe anti-vandálico

Blanco

Alimentación posterior **A3590J3000** € 264,00

Ver cuadro compatibilidades grifería pág. 180

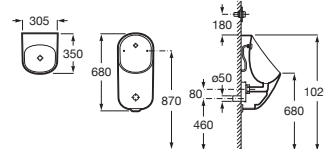

Proton

Urinario Roca Rimless®

Incluye kit de fijación, flexible de alimentación, sifón y tapón desagüe anti-vandálico

Blanco

Alimentación superior **A3590J2000** € 264,00

Ver cuadro compatibilidades grifería pág. 180



Urinarios

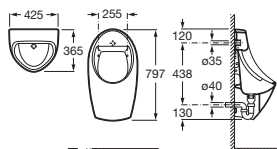

Euret

Urinario

Incluye enchufe alimentación, sifón, kit de fijación y enchufe desagüe

Blanco

Alimentación posterior **A35945F000** € 274,00

Ver cuadro compatibilidades grifería pág. 180

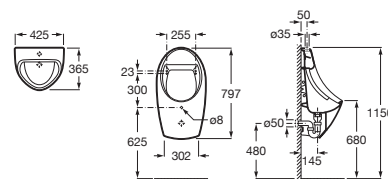

Euret

Urinario

Incluye enchufe alimentación, sifón, kit de fijación y enchufe desagüe

Blanco

Alimentación superior **A35945H000** € 274,00

Ver cuadro compatibilidades grifería pág. 180

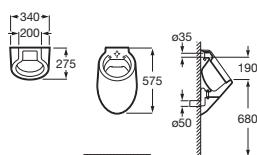

Spun

Urinario

Incluye sifón, juego de fijación, manguito de alimentación 1/2" con enchufe

Blanco

Alimentación posterior. Sin tapa **A353147000** € 256,00

Alimentación posterior. Con tapa **A353148000** € 284,00

Ver cuadro compatibilidades grifería pág. 180

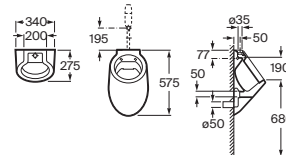

Spun

Urinario

Incluye sifón, juego de fijación, manguito de alimentación 1/2" con enchufe

Blanco

Alimentación superior. Sin tapa **A353149000** € 256,00

Ver cuadro compatibilidades grifería pág. 180

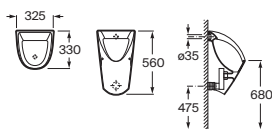

Chic

Urinario

Incluye enchufe de alimentación, sifón, kit de fijación y tapa desagüe

Blanco

Alimentación posterior **A35945J000** € 127,00

Ver cuadro compatibilidades grifería pág. 180

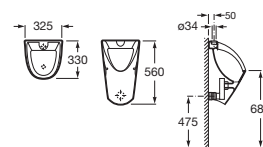

Chic

Urinario

Incluye enchufe de alimentación, sifón, kit de fijación y tapa desagüe

Blanco

Alimentación superior **A35945L000** € 127,00

Ver cuadro compatibilidades grifería pág. 180

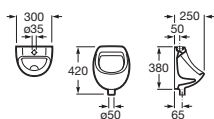

Mini

Urinario

Incluye enchufe de alimentación

Blanco

Alimentación superior **A353145000** € 53,70

Ver cuadro compatibilidades grifería pág. 180

Urinarios

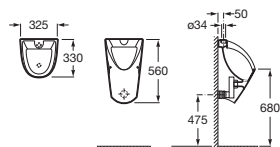

Pack Chic + Fluent

Urinario + fluxor

Pack compuesto por Urinario Chic, fluxor Fluent, tubo exterior, kit fijación urinario y sifón

Blanco

Alimentación superior **A35T45L000** € 244,00

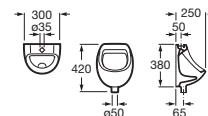

Pack Mini + Instant

Urinario + fluxor

Pack compuesto por Urinario Mini, fluxor Instant, tubo exterior, kit fijación urinario y sifón

Blanco

Alimentación superior **A35T145000** € 154,00

Separadores

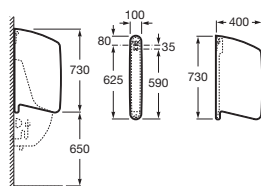

Separador Wing

Separador urinario

Incluye juego de fijación

Blanco

730 x 400 **A387090000** € 181,00



Separador Divo

Separador urinario

Cristal templado de 8 mm, serigrafiado mate a una cara. Perfil mural mate sin tornillos a la vista

A x B

1500 x 500 **AM20205053** € 305,00

700 x 400 **AM20104053** € 284,00



Recambios comerciales

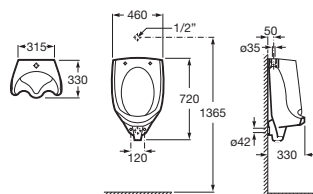

Mural

Urinario

Con manguito, tapón de limpieza y juego de fijación

Blanco

Alimentación superior **A353330001** € 477,00











Kit codo enlace Mural ⁽¹⁾ **AV0016900R** € 35,30

Codo desagüe Mural ⁽¹⁾ **A526505214** € 48,40

(1) Indispensable para el montaje del urinario Mural

Ver cuadro compatibilidades grifería pág. 180

Griferías recomendadas para urinarios

		TEMPORIZADA				FLUXOR	ELECTRÓNICAS	
		Instant	Fluent		Aqualine	Sentronic-V	Sentronic-S	
			 *					
		A5A9077C00	A5A9277C00	A5A9A24C00 A5A9C24C00	A5A9B24C00 A5A9D24C00	A5A9177C00	A5A9A79C00	A5A8102..0**
	Proton (posterior) A3590J3000	•		•				•
	Proton (superior) A3590J2000		•		•			
	Site Mural A359605000	•		•				•
	Site Mural A359607000 A359607001		•		•	•	•	
	Euret A35945F000	•		•				•
	Euret A35945H000		•		•	•	•	
	Spun A353148000	•		•				•
	Spun A353147000	•		•				•
	Spun A353149000		•		•	•	•	
	Chic A35945J000	•		•				•
	Chic A35945L000		•		•	•	•	
	Mini A353145000		•		•	•	•	
	Mural A353330001		•		•	•	•	

* Requiere instalación de tubo exterior. Para urinario Proton ref. A506501000, para el resto, ref. A5A9317C00.

** Requiere subconjunto empotrable ver página 185.

Griferías electrónicas

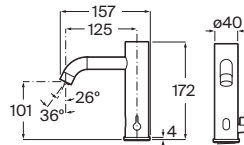

Ona-E

Grifería electrónica mezcladora para lavabo

Con enlaces de alimentación flexibles

Cromado

Alimentación con 4 pilas alcalinas 1,5 V LR6 (AA)	A5A539EC00	€ 360,00
Alimentación con conexión a la red 230 V ⁽¹⁾	A5A559EC00	€ 396,00

(1) Incluye fuente de alimentación

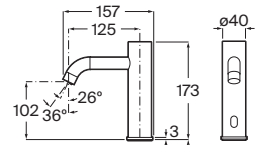
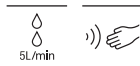

Ona-E

Grifería electrónica para lavabo (un agua)

Con enlaces de alimentación flexibles

Cromado

Alimentación con 4 pilas alcalinas 1,5 V LR6 (AA)	A5A569EC00	€ 299,00
Alimentación con conexión a la red 230 V ⁽¹⁾	A5A579EC00	€ 331,00

(1) Incluye fuente de alimentación

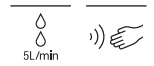

N

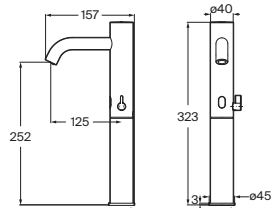

Ona-E

Grifería electrónica mezcladora para lavabo de caño alto

Con enlaces de alimentación flexibles

Cromado

Alimentación con 4 pilas alcalinas 1,5 V LR6 (AA)	A5A5A9EC00	€ 449,00
Alimentación con conexión a la red 230 V ⁽¹⁾	A5A5B9EC00	€ 495,00

(1) Incluye fuente de alimentación

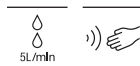

N

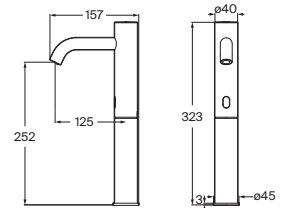

Ona-E

Grifería electrónica mezcladora para lavabo de caño alto (un agua)

Con enlaces de alimentación flexibles

Cromado

Alimentación con 4 pilas alcalinas 1,5 V LR6 (AA)	A5A5C9EC00	€ 357,00
Alimentación con conexión a la red 230 V ⁽¹⁾	A5A5D9EC00	€ 399,00

(1) Incluye fuente de alimentación

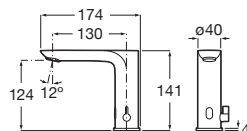
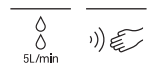

Cala-E

Grifería electrónica mezcladora para lavabo

Con enlaces de alimentación flexibles

Cromado

Alimentación con 4 pilas alcalinas 1,5 V LR6 (AA)	A5A536EC00	€ 295,00
Alimentación con conexión a la red 230 V ⁽¹⁾	A5A556EC00	€ 329,00

(1) Incluye fuente de alimentación

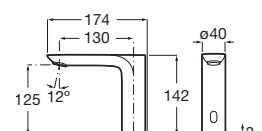
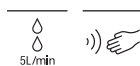

Cala-E

Grifería electrónica para lavabo (un agua)

Con enlaces de alimentación flexibles

Cromado

Alimentación con 4 pilas alcalinas 1,5 V LR6 (AA)	A5A566EC00	€ 276,00
Alimentación con conexión a la red 230 V ⁽¹⁾	A5A576EC00	€ 303,00

(1) Incluye fuente de alimentación

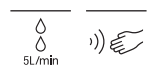

Griferías electrónicas

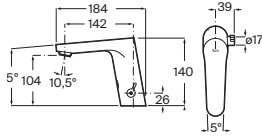

L30-E

Grifería electrónica mezcladora para lavabo

Con enlaces de alimentación flexibles

Cromado

Alimentación con 4 pilas alcalinas 1,5 V LR6 (AA) o **A5A5809C00** € 291,00
 alimentación con conexión a la red 230 V ⁽¹⁾

(1) Incluye fuente de alimentación

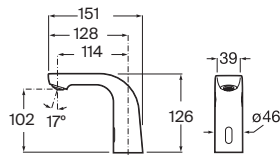

L20-E

Grifería electrónica para lavabo (un agua)

Con enlaces de alimentación flexibles

Cromado

Alimentación con 4 pilas alcalinas 1,5 V LR6 (AA) **A5A5609C00** € 255,00
 Alimentación con conexión a la red 230 V ⁽¹⁾ **A5A5709C00** € 287,00

(1) Incluye fuente de alimentación

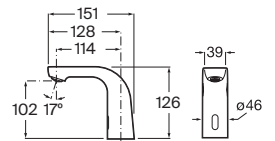
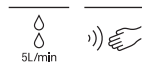

L20-E

Grifería electrónica premezcla para lavabo (agua premezcla)

Con enlaces de alimentación flexibles

Cromado

Alimentación con 4 pilas alcalinas 1,5 V LR6 (AA) **A5A5309C00** € 291,00
 Alimentación con conexión a la red 230 V ⁽¹⁾ **A5A509C00** € 327,00

(1) Incluye fuente de alimentación

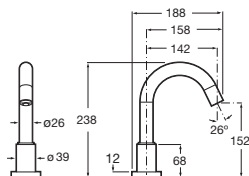
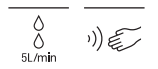

Loft-E

Grifería electrónica para lavabo (un agua)

Con enlaces de alimentación flexibles

Cromado

Alimentación con 4 pilas alcalinas 1,5 V LR6 (AA) **A5A4243C00** € 407,00
 Alimentación con conexión a la red 230 V ⁽¹⁾ **A5A4343C00** € 439,00

(1) Incluye fuente de alimentación

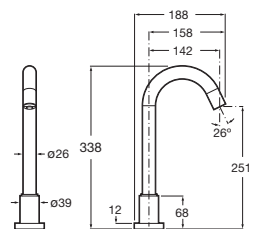
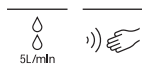

Loft-E

Grifería electrónica para lavabo (un agua)

Con enlaces de alimentación flexibles

Cromado

Alimentación con 4 pilas alcalinas 1,5 V LR6 (AA) **A5A3143C00** € 439,00
 Alimentación con conexión a la red 230 V ⁽¹⁾ **A5A3943C00** € 469,00

(1) Incluye fuente de alimentación

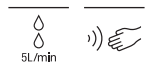

Griferías electrónicas

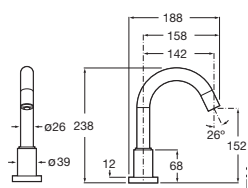

Loft-E

Grifería electrónica premezcla para lavabo (agua premezcla)

Con enlaces de alimentación flexibles Cromado

Alimentación con 4 pilas alcalinas 1,5 V LR6 (AA)	A5A3243C00	€ 451,00
Alimentación con conexión a la red 230 V ⁽¹⁾	A5A3343C00	€ 483,00

(1) Incluye fuente de alimentación

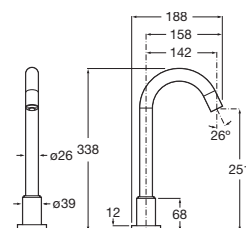

Loft-E

Grifería electrónica premezcla para lavabo (agua premezcla)

Con enlaces de alimentación flexibles Cromado

Alimentación con 4 pilas alcalinas 1,5 V LR6 (AA)	A5A3743C00	€ 483,00
Alimentación con conexión a la red 230 V ⁽¹⁾	A5A3843C00	€ 512,00

(1) Incluye fuente de alimentación

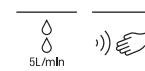

N

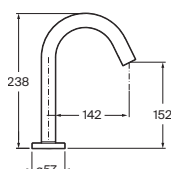

Loft-E Slim

Grifería electrónica para lavabo (un agua)

Con enlaces de alimentación flexibles

Alimentación con 4 pilas alcalinas 1,5 V LR6 (AA)	Cromado	A5A4E43C00	€ 407,00
	Negro mate	A5A4E43NB0	€ 568,00
Alimentación con conexión a la red 230 V ⁽¹⁾	Cromado	A5A4F43C00	€ 437,00
	Negro mate	A5A4F43NB0	€ 613,00

(1) Incluye fuente de alimentación

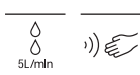
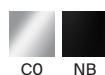

N

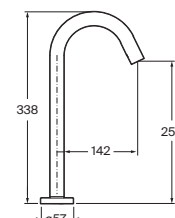

Loft-E Slim

Grifería electrónica para lavabo (un agua)

Con enlaces de alimentación flexibles

Alimentación con 4 pilas alcalinas 1,5 V LR6 (AA)	Cromado	A5A4G43C00	€ 437,00
	Negro mate	A5A4G43NB0	€ 613,00
Alimentación con conexión a la red 230 V ⁽¹⁾	Cromado	A5A4H43C00	€ 469,00
	Negro mate	A5A4H43NB0	€ 659,00

(1) Incluye fuente de alimentación

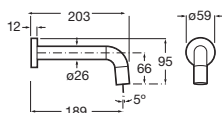
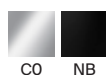

Loft-E

Grifería electrónica mural para lavabo (un agua)

Con caño de 203 mm y enlaces de alimentación flexibles

Alimentación con 4 pilas alcalinas 1,5 V LR6 (AA)	Cromado	A5A5643C00	€ 359,00
	N Negro mate	A5A5643NB0	€ 501,00
Alimentación con conexión a la red 230 V ⁽¹⁾	Cromado	A5A5743C00	€ 395,00
	N Negro mate	A5A5743NB0	€ 552,00

(1) Incluye fuente de alimentación

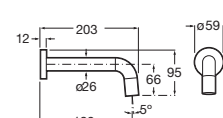
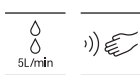
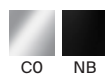

Loft-E

Grifería electrónica mural para lavabo (agua premezcla)

Con caño de 203 mm y enlaces de alimentación flexibles

Alimentación con 4 pilas alcalinas 1,5 V LR6 (AA)	Cromado	A5A3543C00	€ 400,00
	N Negro mate	A5A3543NB0	€ 560,00
Alimentación con conexión a la red 230 V ⁽¹⁾	Cromado	A5A3643C00	€ 439,00
	N Negro mate	A5A3643NB0	€ 613,00

(1) Incluye fuente de alimentación

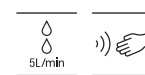
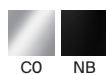

Griferías electrónicas

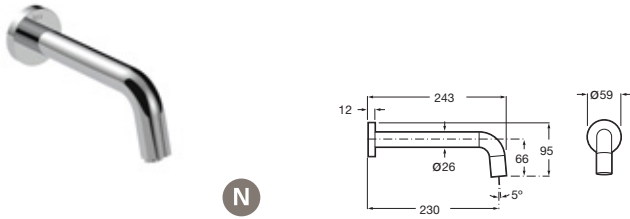

N

Loft-E

Grifería electrónica mural para lavabo (un agua)

Con caño de 243 mm y enlaces de alimentación flexibles

Alimentación con 4 pilas alcalinas 1,5 V LR6 (AA)	Cromado	A5A5A43C00	€ 377,00
	Negro mate	A5A5A43NBO	€ 529,00
Alimentación con conexión a la red 230 V ⁽¹⁾	Cromado	A5A5B43C00	€ 415,00
	Negro mate	A5A5B43NBO	€ 581,00

(1) Incluye fuente de alimentación

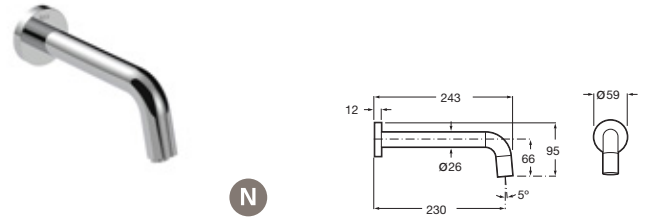
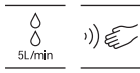
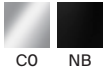

N

Loft-E

Grifería electrónica mural para lavabo (agua premezcla)

Con caño de 243 mm y enlaces de alimentación flexibles

Alimentación con 4 pilas alcalinas 1,5 V LR6 (AA)	Cromado	A5A3I43C00	€ 420,00
	Negro mate	A5A3I43NBO	€ 589,00
Alimentación con conexión a la red 230 V ⁽¹⁾	Cromado	A5A3J43C00	€ 457,00
	Negro mate	A5A3J43NBO	€ 636,00

(1) Incluye fuente de alimentación

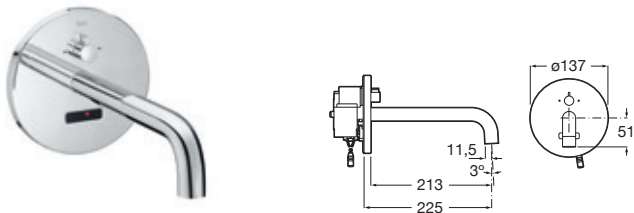
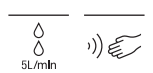
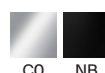

Sentronic-E

Grifería electrónica mezcladora mural para lavabo

Cromado

Subconjunto exterior grifería lavabo mural	A5A4602C00	€ 992,00
A completar con:	A525874603	€ 275,00
Subconjunto empotrado con llave de corte		

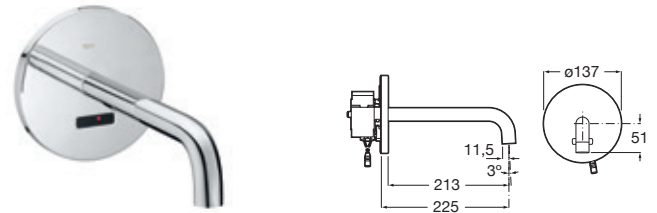
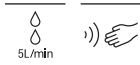

Sentronic-E

Grifería electrónica mural para lavabo (un agua)

Cromado

Subconjunto exterior grifería lavabo mural	A5A4702C00	€ 849,00
A completar con:	A525874603	€ 275,00
Subconjunto empotrado con llave de corte		

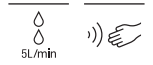

Dosificador electrónico

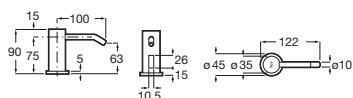

Ona

Dosificador electrónico con sensor de jabón o gel hidroalcohólico de repisa

Cromado

Alimentación con 4 pilas alcalinas de 1,5 V D/LR20 **A818020C00** € 127,00 (no incluidas)

Alimentación con conexión a la red 230 V ⁽¹⁾ **A818014C00** € 127,00

(1) Incluye fuente de alimentación



Fluxores electrónicos

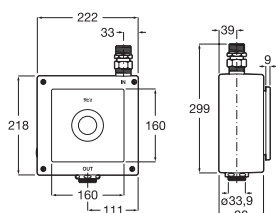

Sentronic-R

Fluxor electrónico para inodoro

Cromado

Alimentación con conexión a la red 230 V **A5A9102C00** € 748,00

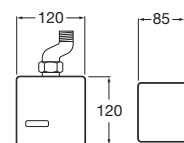

Sentronic-S

Fluxor electrónico para urinario

Dimensiones placa frontal 120 x 120

Dimensiones subconjunto emp 110 x 110 x 92

Cromado

Subconjunto exterior placa frontal	Cromado	A5A8102C00	€ 145,00
	Mate	A5A8102CM0	€ 145,00
	Blanco	A5A8102B00	€ 145,00

A completar con:

Subconjunto empotrado con conexión a la red 230 V **A525165303** € 319,00

Subconj empotrado con 4 pilas alcalinas 1,5V LR6(AA) **A525165203** € 256,00

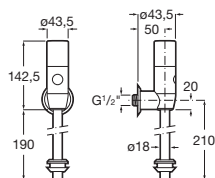

Sentronic-V

Fluxor electrónico visto de urinario

Cromado

Alimentación con una pila alcalina de 9 V **A5A9A79C00** € 468,00

Mando a distancia para urinario. Para regular la longitud de detección y tiempo de descarga del fluxor Sentronic-V **A525081207** € 90,50



Grifería temporizada Instant

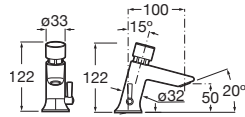

Grifería temporizada de repisa para lavabo Cromado
Con rompechorros **A5A3177C00** € 248,00

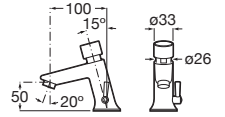
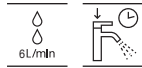

Grifería temporizada de repisa para lavabo. Versión ECO Cromado
Con rompechorros **A5A3377C00** € 257,00

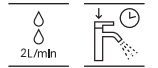

Grifería certificada por AENOR

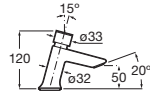

Grifería temporizada de repisa para lavabo Cromado
Con rompechorros **A5A4277C00** € 82,70
Con sistema anti-bloqueo **A5A4577C00** € 88,30

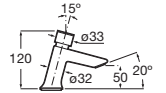
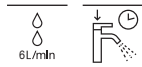

Grifería temporizada de repisa para lavabo. Versión ECO Cromado
Con rompechorros **A5A4477C00** € 116,00

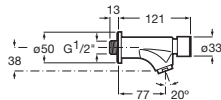
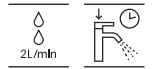

Grifería temporizada de pared para lavabo Cromado
Con rompechorros **A5A7877C00** € 75,20

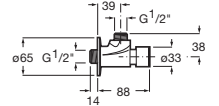

Grifería de paso angular temporizada exterior para ducha Cromado
A5A2777C00 € 86,40

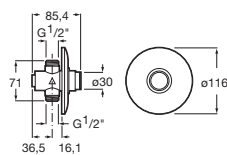

Grifería de paso recto temporizada empotrable para ducha Cromado
A5A2677C00 € 90,10



Grifería Instant Foot

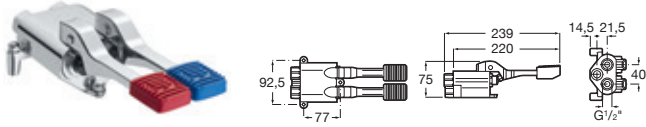

Grifería temporizada de pedal Cromado
 Instalación suelo **A505128600** € 240,00

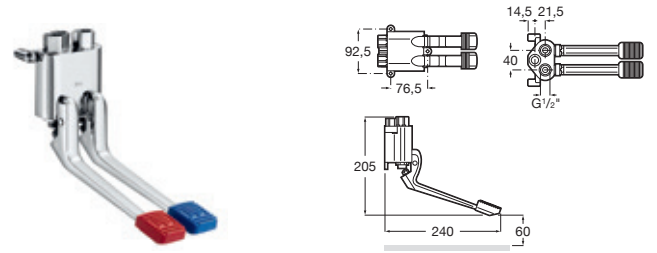

Grifería temporizada de pedal Cromado
 Instalación pared **A505128700** € 284,00

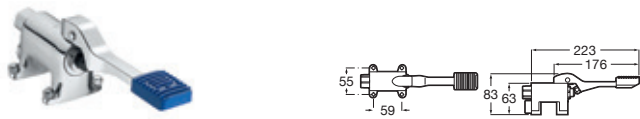

Grifería temporizada de pedal de un agua Cromado
 Instalación suelo **A505127800** € 148,00

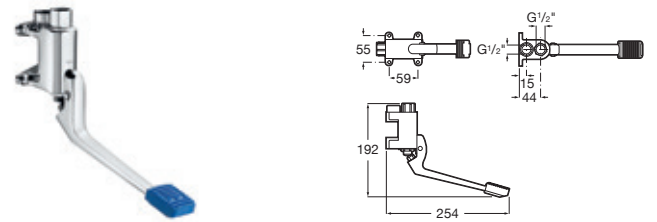

Grifería temporizada de pedal de un agua Cromado
 Instalación pared **A505127900** € 207,00



Caño Cromado
 De repisa **A505327000** € 68,40

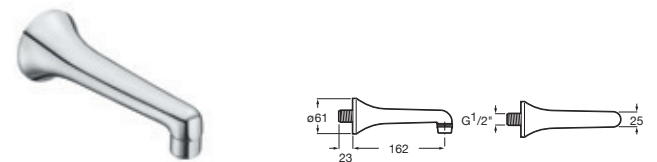

Caño Cromado
 De pared **A505326900** € 51,20

Grifería Instant Pro

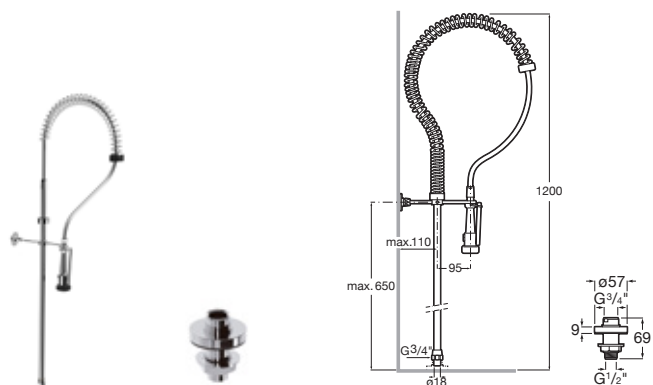

Caño espiral industrial 1200 mm

Cromado

1 salida	A5A8564C00	€ 451,00
Adaptador para instalación sobreencimera	A5A8764C00	€ 180,00

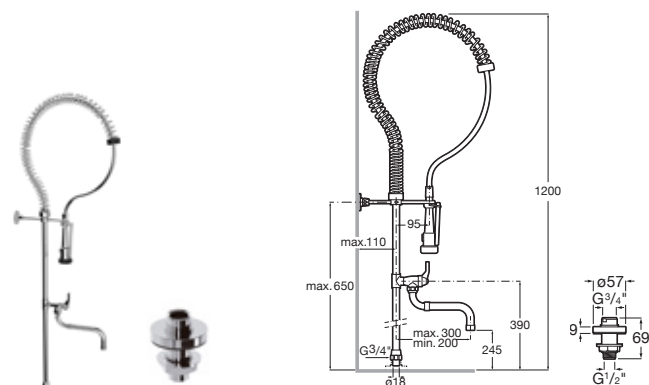

Caño espiral industrial 1200 mm

Cromado

2 salidas	A5A8664C00	€ 568,00
Adaptador para instalación sobreencimera	A5A8764C00	€ 180,00

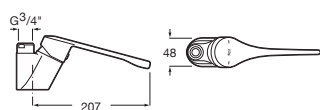

Grifería para cocina para caño espiral industrial 1200 mm

Cromado

A completar con un caño espiral industrial	A5A8064C00	€ 88,30
--	-------------------	---------

Grifería temporizada Fluent

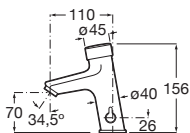

Grifería temporizada de repisa para lavabo

Cromado

Con aireador. Caudal 5l/m	A5A3A24C00	€ 263,00
Con aireador ECO. Caudal 2l/min	A5A3B24C00	€ 287,00

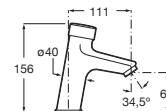

Grifería temporizada de repisa para lavabo

Cromado

Con aireador. Caudal 5l/min	A5A4A24C00	€ 106,00
Con aireador ECO. Caudal 2l/min	A5A4B24C00	€ 124,00

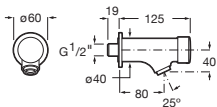
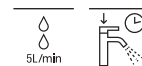

Grifería temporizada de pared para lavabo

Cromado

Con aireador	A5A7A24C00	€ 103,00
--------------	-------------------	----------

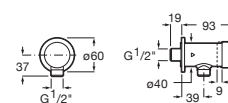
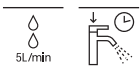

Grifería de paso angular temporizada exterior para urinario

Cromado

Descarga estándar	A5A9B24C00	€ 92,40
Descarga ECO	A5A9D24C00	€ 106,00
Tubo externo para urinario	A5A9317C00	€ 32,10

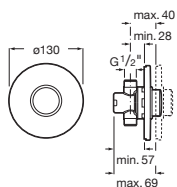

Grifería de paso recto temporizada empotrable para urinario con rosetón

Cromado

Descarga estándar	A5A9A24C00	€ 107,00
Descarga ECO	A5A9C24C00	€ 116,00



Grifería temporizada Avant

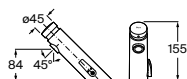

Grifería temporizada de repisa para lavabo Cromado
 Con rompechorros **A5A3A79C00** € 337,00

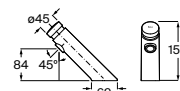
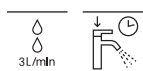

Grifería temporizada de repisa para lavabo Cromado
 Con rompechorros **A5A4A79C00** € 208,00

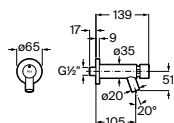
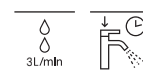

Grifería temporizada de pared para lavabo Cromado
 Con rompechorros **A5A7A79C00** € 111,00

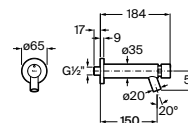

Grifería temporizada de pared para lavabo caño largo Cromado
 Con rompechorros **A5A7B79C00** € 122,00

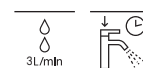

N

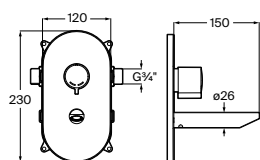

Grifería temporizada mezcladora empotrable para lavabo Cromado
 Caño de 243mm **A5A3679C00** € 604,00

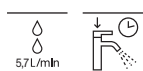

N

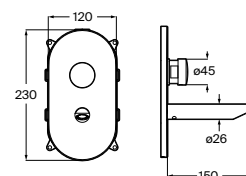

Grifería temporizada empotrable para lavabo (un agua) Cromado
 Caño de 243mm **A5A3779C00** € 531,00

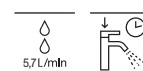

Grifería temporizada Avant

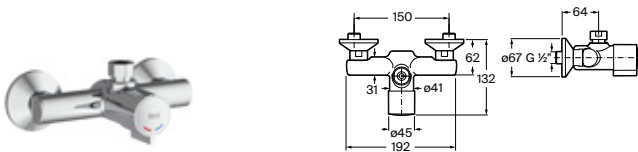

Grifería temporizada para ducha mural Cromado
A5A2D79C00 € 309,00
 A completar con conjunto de tubo, brida y rociador A5B9979C00

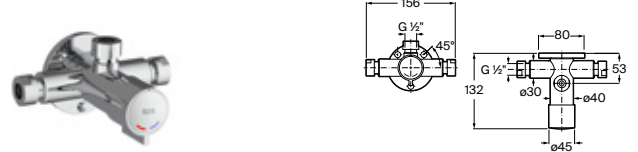

Grifería temporizada para ducha, instalación vista Cromado
A5A2C79C00 € 281,00
 A completar con conjunto de tubo, brida y rociador A5B9979C00

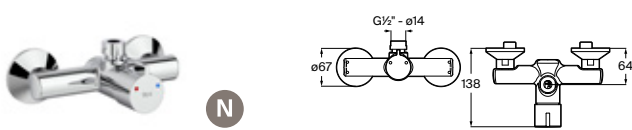

Grifería temporizada termostática para ducha mural Cromado
A5A2E79C00 € 351,00
 A completar con conjunto de tubo, brida y rociador A5B9979C00.

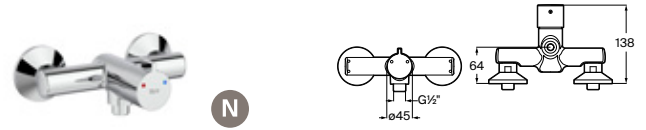

Grifería temporizada termostática para ducha mural Cromado
A5A2F79C00 € 361,00

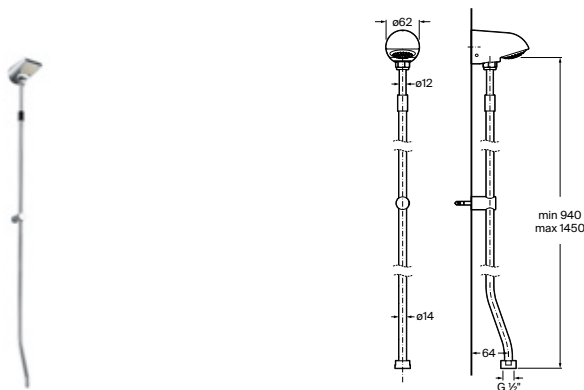

Conjunto de tubo, brida y rociador Cromado
A5B9979C00 € 196,00

Grifería temporizada Avant

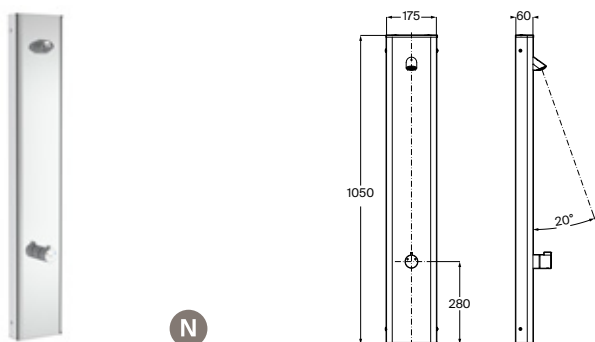

N

Panel de ducha temporizada en acero inoxidable con mezclador termostático

Mezclador	A5A2679C00	€ 1.113,00
-----------	-------------------	------------

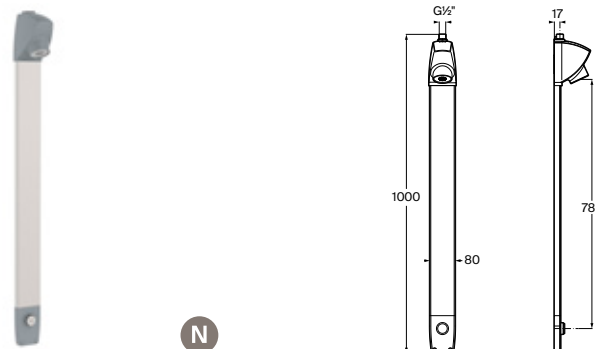

N

Panel de ducha temporizada en aluminio y PVC (un agua)

1 agua	A5A2979C00	€ 339,00
--------	-------------------	----------

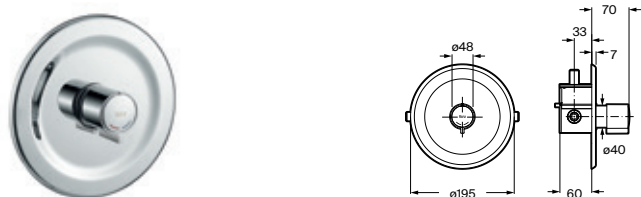

Grifería temporizada empotrable para ducha

		Cromado	
Con rosetón	Estándar	A5A2B79C00	€ 404,00
	Sist. Antilegionela	N A5A2H79C00	€ 424,00

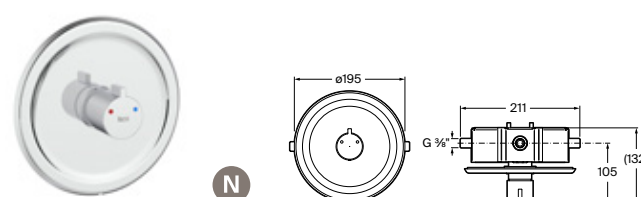

N

Grifería temporizada termostática empotrable para ducha

		Cromado	
Con rosetón	Estándar	A5A2579C00	€ 451,00
	Sist. Antilegionela	A5A2G79C00	€ 477,00

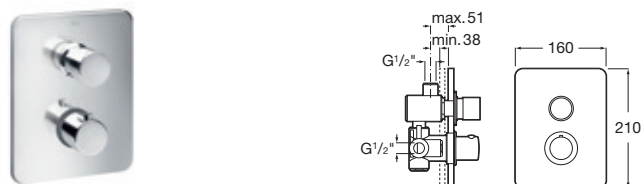

Grifería termostática empotrable para ducha

		Cromado	
		A5A0679C00	€ 680,00



Grifería termostática Micro-T Premezcla

		Cromado	
		A5A0179C00	€ 136,00



Fluxores para Inodoros

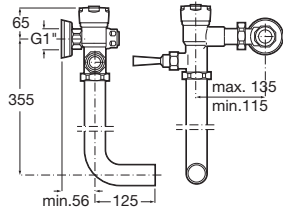

Fluxor exterior Gem para inodoro*		Cromado
Tubo descarga curvo de 1". Para inodoro y vertedero Garda	A526900610	€ 444,00

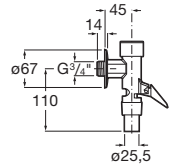

Fluxor Aqualine Basic para inodoro		Cromado
De 3/4"	A5A9477C00	€ 87,90
Tubo fluxor	A505521600	€ 38,80

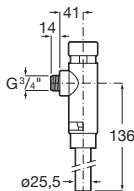

Fluxor Aqualine Plus para inodoro		Cromado
De 3/4"	Doble descarga 6/3 litros	A5A9577C00 € 215,00
	Doble descarga 4/2 litros	A5A9C77C00 € 141,00
Tubo fluxor	A505521600	€ 38,80

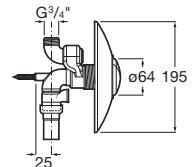

Fluxor de empotrar 3/4 para inodoro		Cromado
Doble descarga 6/3 l	A5A9779C00	€ 443,00

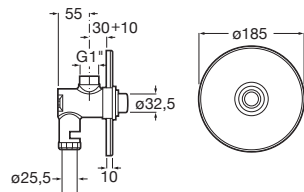

Fluxor Aqualine empotrado para inodoro		Cromado
Descarga 6 litros	A5A9677C00	€ 255,00

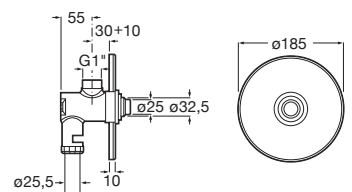



















Fluxor Aqualine empotrado para inodoro		Cromado
De doble descarga 6/3 litros	A5A9777C00	€ 320,00
De doble descarga 4/2litros	A5A9D77C00	€ 320,00



Complementos		Cromado
Complemento tubo de descarga fluxor exterior	AG0094703R	€ 79,90
Tubo fluxor	A505521600	€ 38,80
Válvula antirretorno para fluxor	A525936100	€ 118,00
Enchufe fluxor para tazas supendidas 55 x 32	AV0016200R	€ 2,63

Medidas en mm
 Toda factura tendrá el recargo del IVA / La presente tarifa anula las anteriores
 * Hasta fin de existencias

Fluxores recomendados para inodoros

WC - Tanque alto		Victoria	The Gap	The Gap Round	Inspira	Ona	Tura
							
		A344V03000 A344V04000	A347479000 A347737000	A3470N7000 A3470N8000	A347526..0 A347537..0	A347687..0	A347697..0
Fluxor 4/2	 Aqua 4/2L A5A9C77000	•					
	 Sentronic-R A5A9102C00		•	•	•	•	•
	 Aqua 4/2L A5A9D77000		•	•	•	•	•
WC - Suspendido		Victoria	The Gap	The Gap Round	Inspira	Ona	Tura
							
		A346V03000	A34647L000 A34647A000 A34647F000	A3460NL000 A3460NB000 A3460N7000	A346527..0 A346528..0 A346537..0	A346687..0 A346688..0	A346697..0
Fluxor 4/2	 Duplo WC Electronico A890092200		•	•	•	•	•
	 Duplo WC Fluxor 4/2L A89009210S	•	•	•	•	•	•

Tazas infantiles

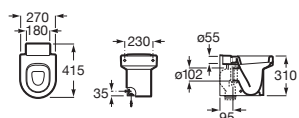

Happening Baby

Taza infantil adosada a pared para tanque alto, empotrable o fluxor

415 mm de longitud. Altura 310

Blanco

Taza baby para tanque alto, tanque empotrable o fluxor, salida dual con juego de fijación y enchufe unión **A347115000** € 246,00

Aro de elastómero con bisagras de poliamida **A801116..4 (1)** € 64,30

(1) En Blanco 00 o Amarillo 71

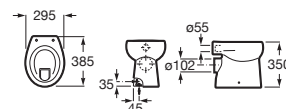

Baby

Taza infantil de fondo plano para tanque alto, empotrable o fluxor

385 mm de longitud. Altura 350

Blanco

Salida evacuación horizontal **A344PB7000** € 171,00

Aro para taza infantil Baby **A801PB6004** € 44,80

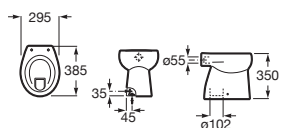

Baby

Taza infantil de fondo plano para tanque alto, empotrable o fluxor

385 mm de longitud. Altura 350

Blanco

Salida evacuación vertical **A344PB8000** € 171,00

Aro para taza infantil Baby **A801PB6004** € 44,80



Placas turcas

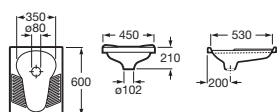

Oriental

Placa turca

Blanco

A345090001 € 66,20

Trituradores sanitarios

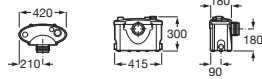

D-Trit

Triturador sanitario

Triturador sanitario equipado con filtro de tambor y cuchillas giratorias de acero inoxidable, de alto rendimiento y bajo nivel sonoro. Compatible con tuberías de evacuación de 22, 28, 32 y 40 mm

A869000000 € 583,00

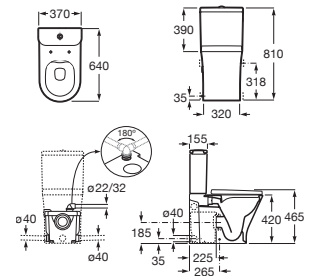

The Gap Round D-Trit

Inodoro de tanque bajo con triturador

640 mm de longitud

Blanco

Pack: Inodoro adosado a pared, tanque con juego de mecanismos de doble descarga 4,5/3 litros, taza Roca Rimless® y asiento y tapa de Supralit® de caída amortiguada



Tanques altos

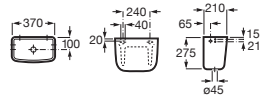

Universal

Tanque alto

Blanco

Tanque alto porcelana **A343900001** € 34,10

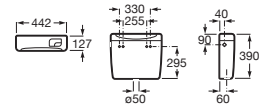

Universal

Tanque alto

Blanco

Tanque alto/semi alto de plástico, descarga 3/6 lts. Para instalación en alto se requiere tubo ref. A890200001

A890200000 € 92,80

Tubo para instalación en alto **A890200001** € 8,03

Vertederos

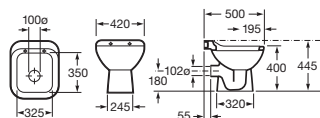

Garda

Vertedero

Blanco

Vertedero salida horizontal con enchufe de unión, rejilla desagüe y juego de fijación **A371055000** € 200,00

Reja de acero inoxidable con almohadilla para vertedero **A526005510** € 90,20

Recambios

Rejilla de porcelana del desagüe Garda **A388650001** € 6,74

Juego de tornillos de fijación Victoria (taza y bidé) y Garda **AV0007200R** € 2,72

